



温州金宏电器有限公司
WENZHOU JINHONG ELECTRICAL APPLIANCE CO., LTD

49F

继电器插座系列

Relay Socket Automation Components

Version 2024

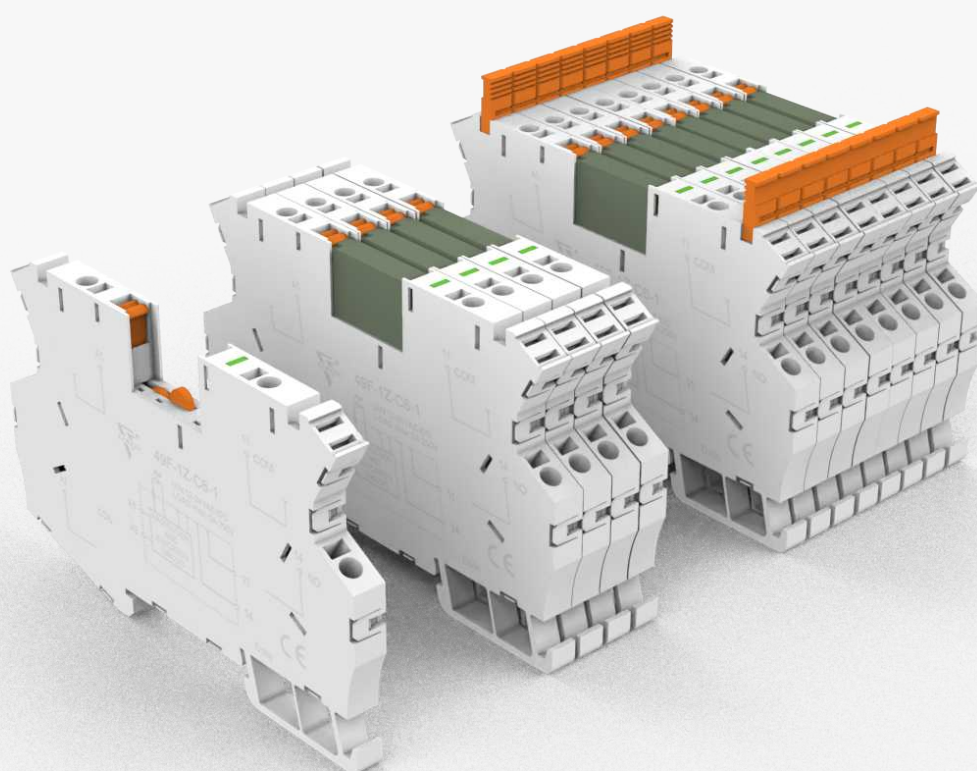

49F-1Z-C6

继电器插座系列

Relay Socket Automation Components

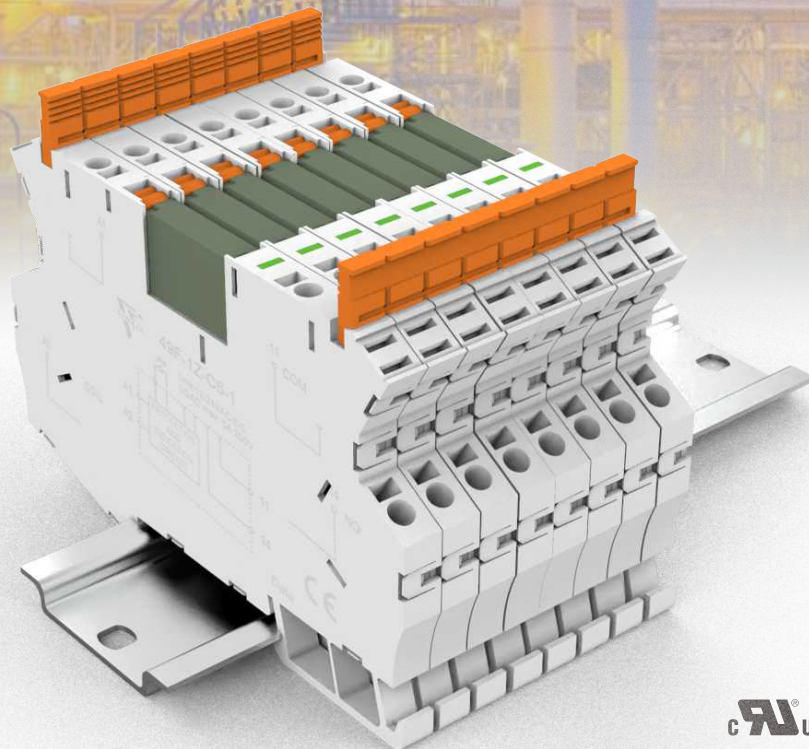

49F-1Z-C6

继电器插座系列
Relay Socket Automation Components

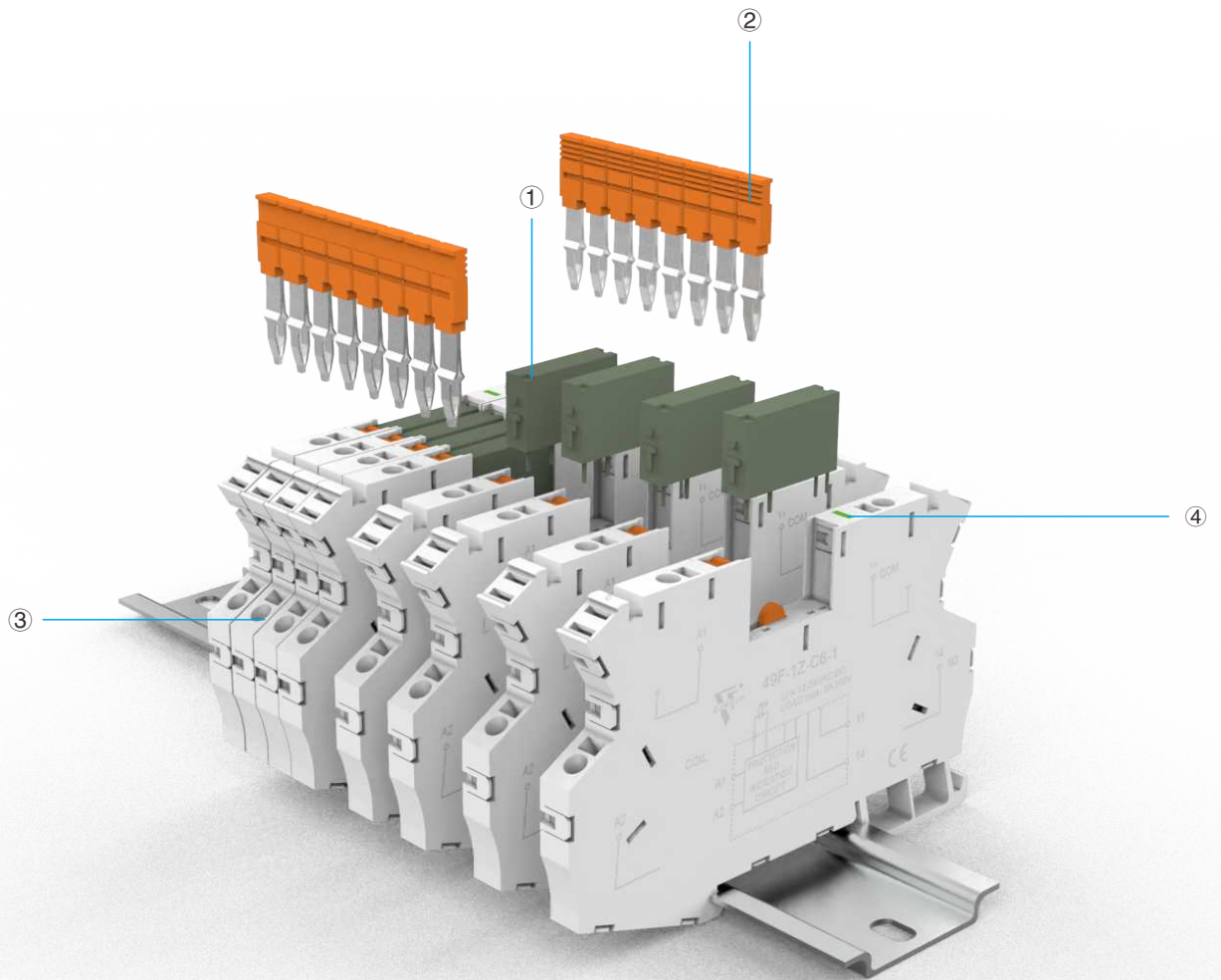

① 继电器 Relay
ZJ49FD

② 连接桥 Link bridge

③ 继电器插座 Relay Socket
49F-1Z-C6

④ 指示灯 Indicator light
■ 红色: 交流 ■ 绿色: 直流
Red: AC Green: DC

49F-1Z-C6

继电器插座系列

Relay Socket Automation Components

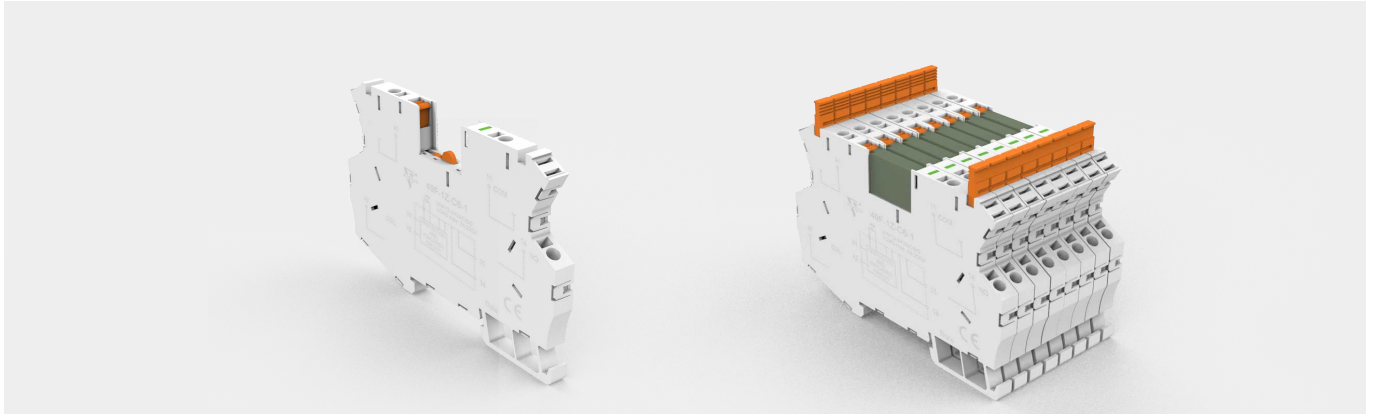

Type 型号		49F-1Z-C6-1	49F-1Z-C6-5
Nominal load 额定负载	电流 Current	5A	5A
	电压 Voltage	250V	250V
介质耐压 Dielectric strength		3000V/min	3000V/min
剥线长度 Stripping length		10mm	10mm
最小线径 Minimum wire diameter		1x0.5mm ² 1x21 AWG	1x0.5mm ² 1x21 AWG
最大线径 Maximum wire diameter		1x2.5mm ² 1x14 AWG	1x2.5mm ² 1x14 AWG
机械寿命 Mechanical life		约2x10 ²	约2x10 ²
连接方式 Connection method		直插式连接 Push-in connection	直插式连接 Push-in connection
环境温度 Ambient temperature range		-40°C ~ +85°C	-40°C ~ +85°C
Socket coil end input voltage 插座线圈端输入电压		(12-24)V AC/DC	(6-24)V DC
Applicable relay coil voltage 适用继电器线圈电压		(12-24)V DC	(6-24)V DC

外形及安装尺寸 Dimensions

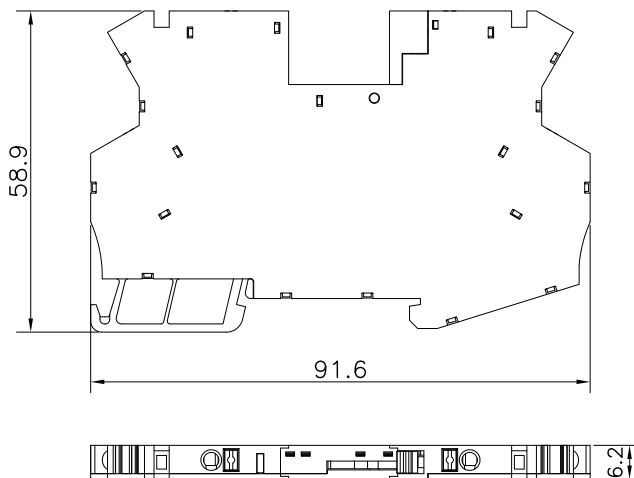

接线图 Wiring Diagram

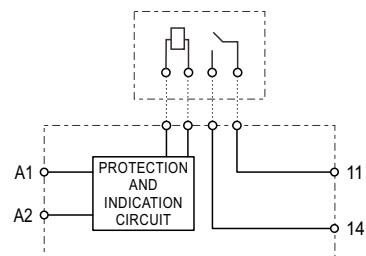

49F-1Z-C6

继电器插座系列
Relay Socket Automation Components



配件/ Accessory

跨接片/Jumper

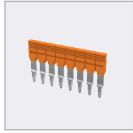

49F-H0(橙色/Orange)	49F-H1(蓝色/Blue)	49F-HR(红色/Red)	49F-HB(黑色/Black)
-------------------	-----------------	----------------	------------------

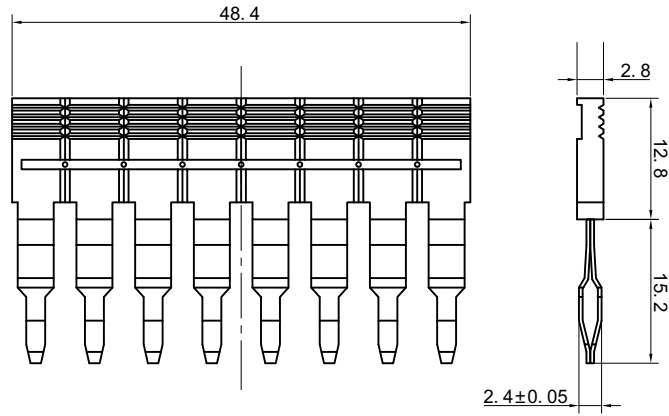

写字板/Tablet



49F-T

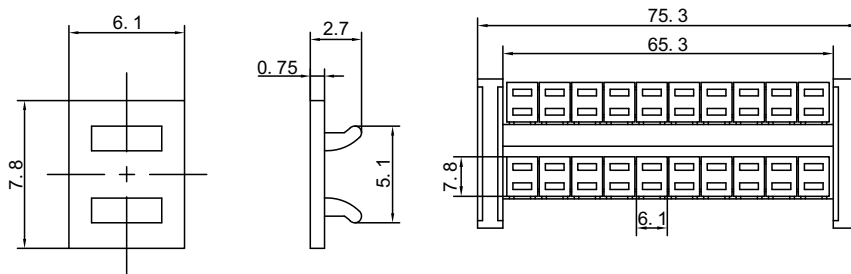



本文件已打印在生态纸上
Printing with environmentally friendly paper



本手册属温州金宏电器有限公司印制，仅用于说明本系列产品的相关信息。金宏电器可能因技术升级或采用更新的生产工艺而改进手册有关内容，或对本手册的印刷错误及不准确的信息进行必要的改进和更改，恕不另行通知。商家订货时请联系公司，以证实相关信息。

This manual is intended for on-site installation and product use by Jinhong Electric(KINRED) Please retain the technical documentation and drawings for future reference.

For detailed information regarding this manual, please contact the relevant department or our customer service. Specifications are subject to change without prior notice.

本公司已完成宣传文案整改，所有业务资料均以现行最新版目录为准，旧版作废。

We have revised non-compliant wording in old catalogs. The latest version shall prevail; all previous versions are invalid.



温州金宏电器有限公司
WENZHOU JINHONG ELECTRICAL APPLIANCE CO., LTD

更专业的技术服务



www.wzjh.cc



T +86-577-57187518
F +86-577-57187788
E admin@wzjh.cc

Address

浙江省乐清市城东产业功能区永兴二路10号
Yongxing second Road 10#, Chengdong industrial functional area, Yueqing city, Zhejiang Province.